

Door Structure

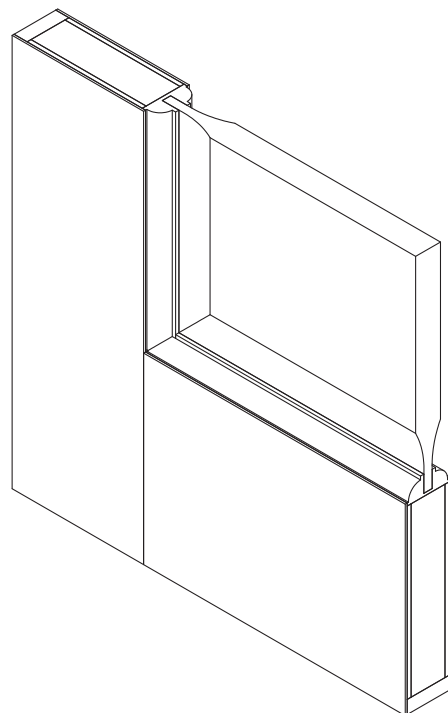

Design of Frame

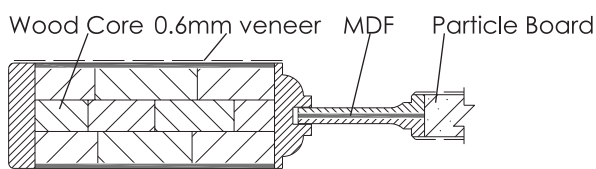
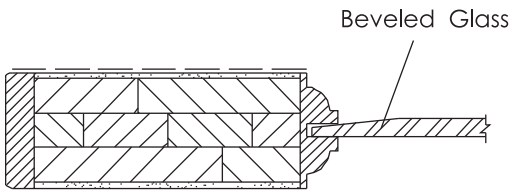
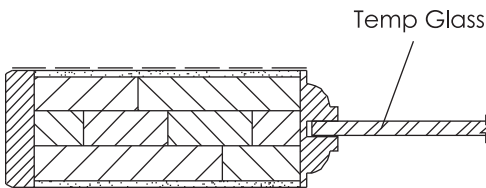
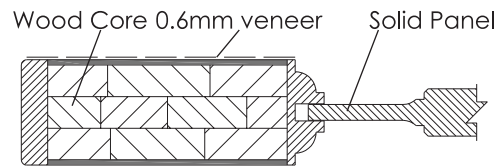
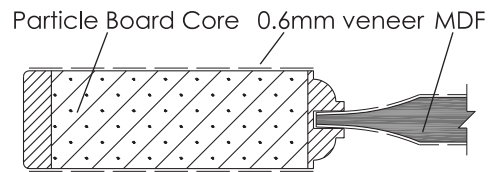
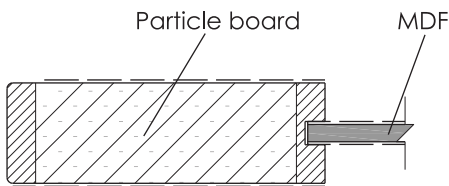
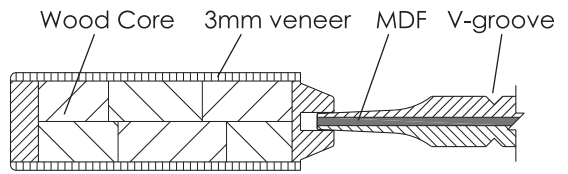
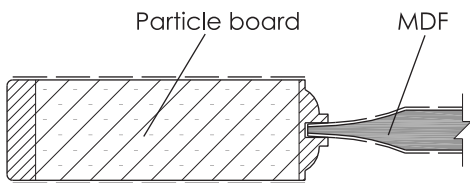
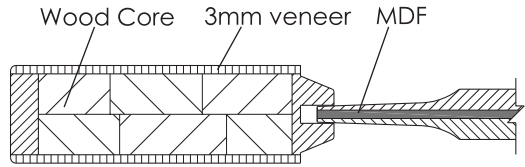
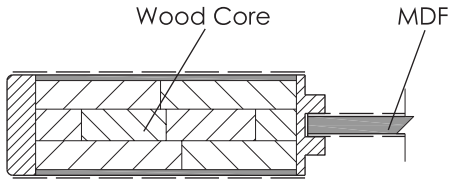
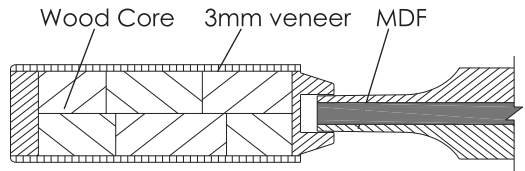
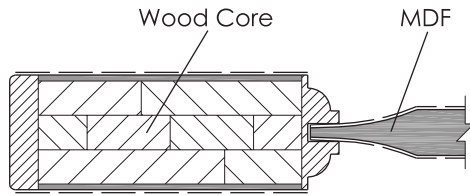
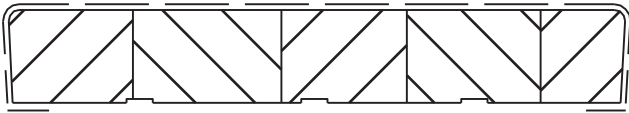

FJ-01
Flat Jamb (wrapped veneer)

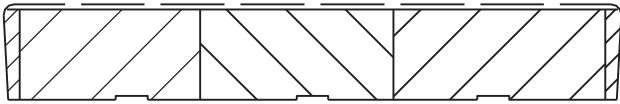

FJ-02
Flat Jamb

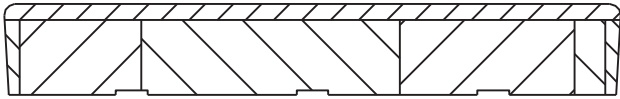

FJ-03
Flat Jamb

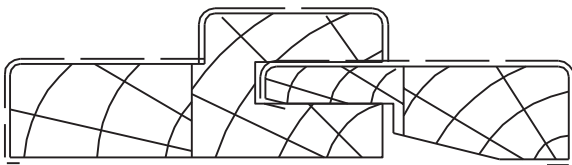

SJ-01
Split Jamb

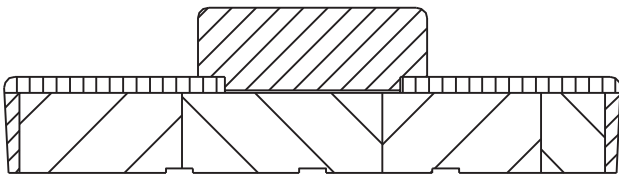

DJ-01
Double Rabbet Jamb

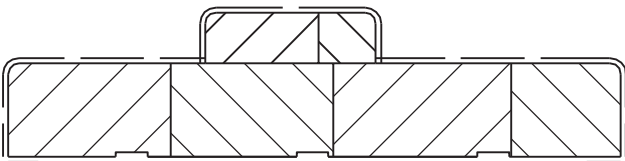

DJ-01
Double Rabbet Jamb

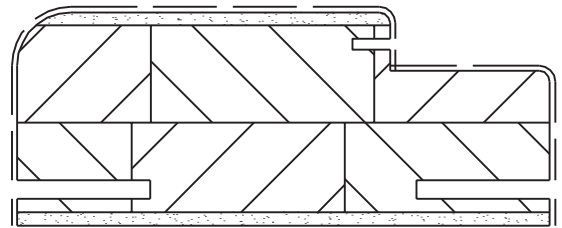

RJ-02
Wrapped Veneer Jamb

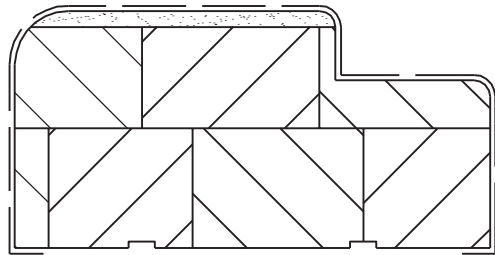

RJ-03
Wrapped Veneer Jamb

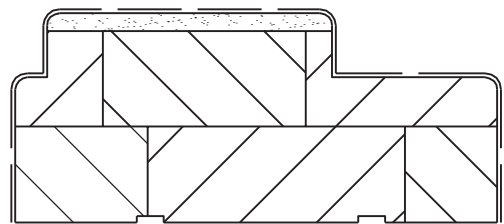

RJ-04
Wrapped Veneer Jamb

Design of Molding

Casing

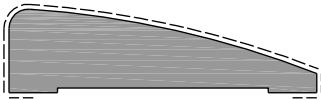

WM315, WM316, WM327,
WM328, WM329, WM448

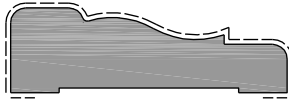

WM351, WM356

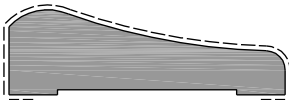

WM321

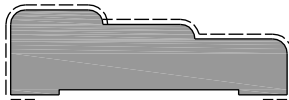

WM387, WM683

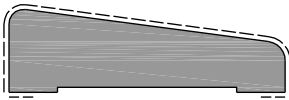

WM324

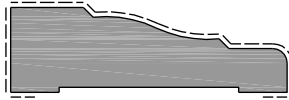

WM444

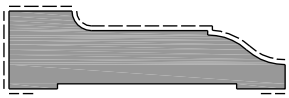

WM346

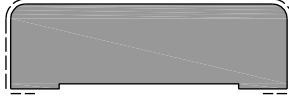

WM410, WM412, WM413,
WM430, WM432, WM433,
WM452, WM453, WM472,
WM473, WM492, WM493

Base

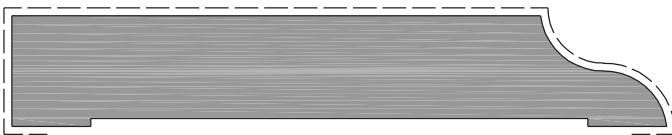

WM658, WM660, WM662, WM664

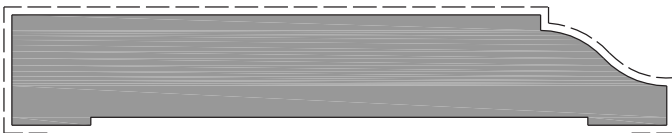

WM618, WM620, WM622, WM623, WM624, WM632, WM633,
WM634

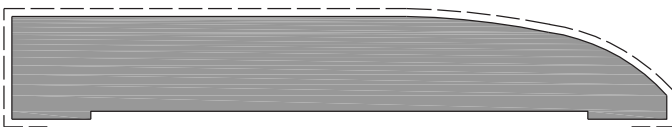

WM709, WM710, WM712, WM713, WM714, WM722, WM723,
WM724, WM725, WM726

Stops

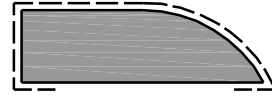

STOP-01

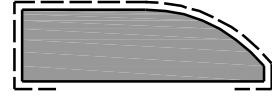

STOP-02

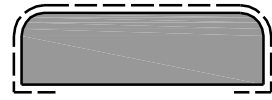

STOP-03

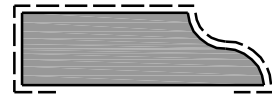

STOP-04

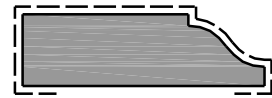

STOP-05